



Installation Manual

E-1000/E-1000UV
Whole House Water Filter

kindwater.com

Have questions? Call us: 888-614-5559

Product Specifications

Congratulations on your purchase of the Kind Water Systems E-1000/E-1000UV Whole House Water Filter. Please visit kindwater.com if you have any questions about your system. Our friendly water filtration specialists are also available by calling 888-614-5559 during normal business hours!

Kind E-1000 Dimensions



- Max Flow Rate:** up to 15 GPM (Gallons Per Minute)
- Max Capacity:** up to 6 Bathrooms
- Connection Size:** 1"
- Operating Pressure:** 25 to 120 PSI
- Operating Temp:** 36° to 120° F
- pH Range:** 6.5 to 9.5
- Max Iron = 0 mg/L** Max Iron = 0 mg/L
- Max Hydrogen Sulfide = 0 mg/L** Max Hydrogen Sulfide = 0 mg/L

Items Included:

Kind E-1000

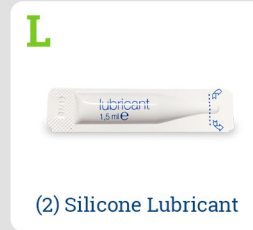
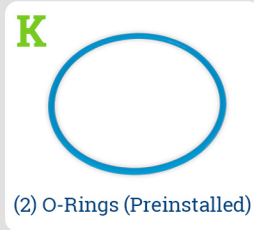

Easy Assembly & Installation

- 1** Open package and account for all items before starting installation.
Note: Remove and discard all cardboard used for packaging.
- 2** Determine the location and water flow direction for the system.
- 3** Turn off the main water supply line to the home.
- 4** Open the nearest faucet (cold water) and leave it open.
Note: Ensure water comes to a stop, this will help verify the main water supply is off
- 5** Install the mounting bracket (A) horizontally to the wall using supplied fasteners.
Note: Be sure to level mounting bracket and properly attach to a wall stud or cement block, ensuring a secure mount. Lag Bolts (F) require a 1/4" drill bit not included. Tapcons (G) require a 5/32" drill bit not included.
- 6** Once the mounting bracket (A) is level and properly mounted, remove the cartridge housings from the manifold and install manifold (B) to the mounting bracket orientating the INLET and OUTLET from left to right as marked on the manifold. Use item (E), (8) stainless steel machine bolts, and washers to attach.
- 7** Apply a layer of lubricant (L) onto each o-ring. Thread housings back onto the manifold counterclockwise. Snug housings using the supplied wrench (H), do not over-tighten.
- 8** Adapt your plumbing connections as needed to the INLET and OUTLET (not included).
*Note: When making your threaded connections to the INLET and OUTLET it is necessary to use both Teflon Tape and Thread Sealant - We recommend **Rectorseal TRU-BLU** which is available at all big box stores.*
Note: Plumbing a shutoff valve prior to system and a bypass is recommended, see Typical Installation Diagram
Note: If you purchased the E-1000UV system, please skip ahead to page 3 of the UV Quick Reference Guide for installation instructions.
- 9** Slowly turn on the main water supply to fill the housings.
- 10** Allow the open faucet to run (cold water) for 10 minutes to flush the system.
- 11** Turn off the faucet and check for leaks, your system is now ready for use!

Please note:

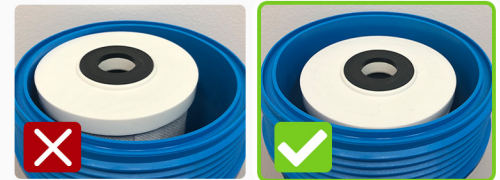

Ensure all cartridges are centered and properly seated down into housing.

Typical Installations - E-1000

Option #1

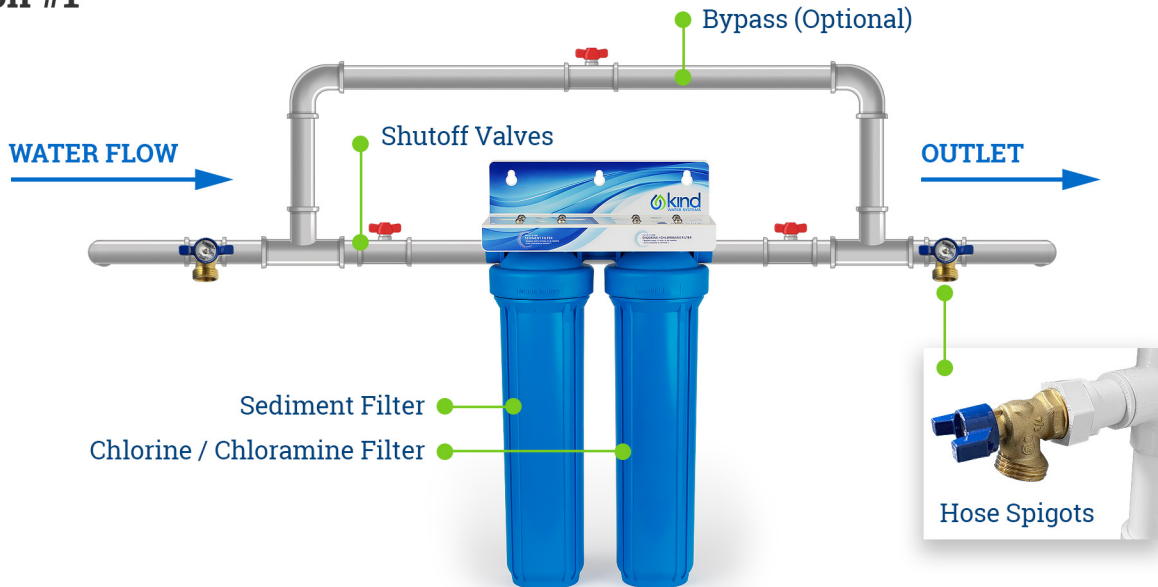

Option #2

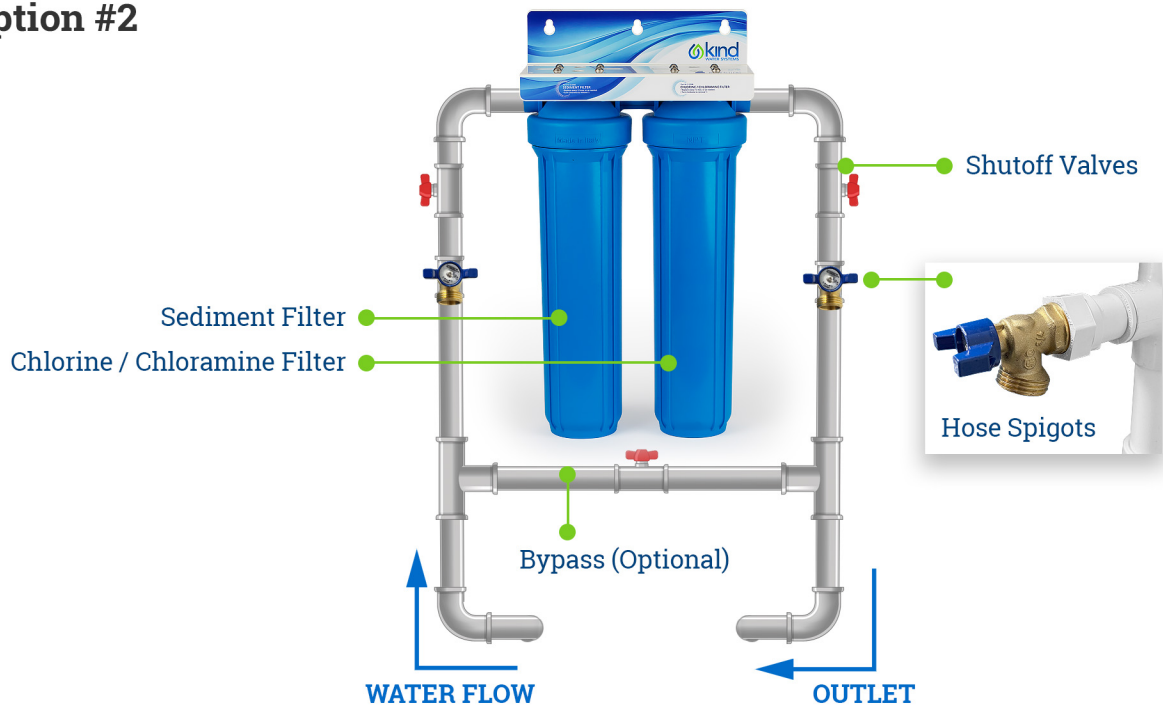

Typical Installations - E-1000UV

Option #1

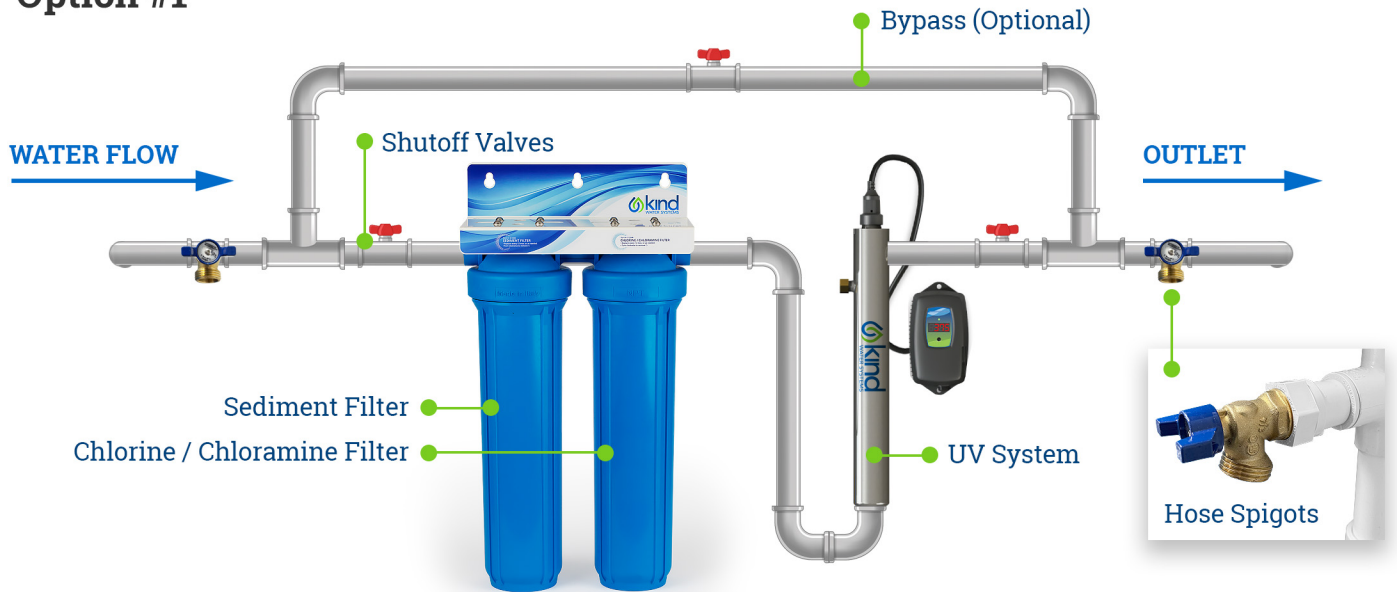

Option #2

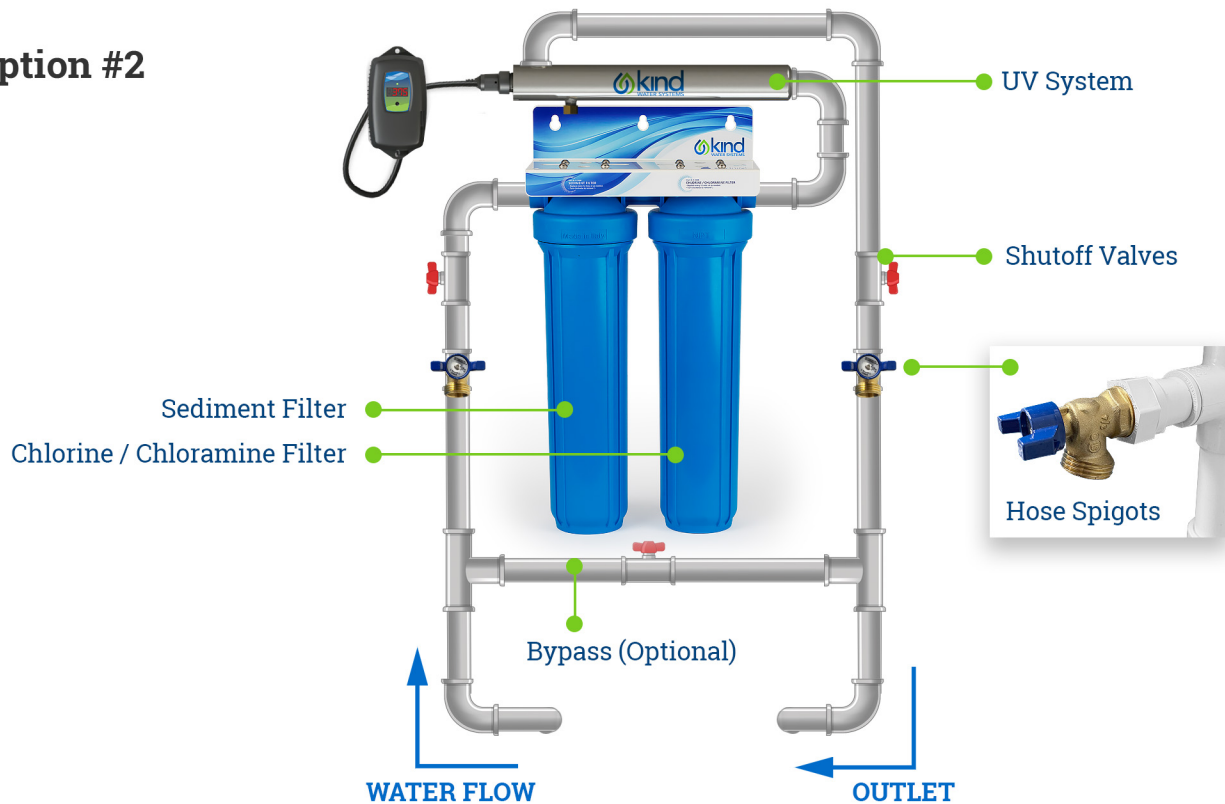

Regular Maintenance

The Sediment and Chlorine/Chloramine Filters will need to be replaced every 12 months.

Note: Depending on water quality

Filter Replacement

- 1 Turn off main water supply.
- 2 Open the nearest cold water faucet and leave open.
- 3 Apply wrench to cartridge housing & turn clockwise to loosen (to the left).
- 4 Remove and discard used o-ring and cartridge.
- 5 Unwrap and install a new cartridge centering on stand pipe.
- 6 Install a new o-ring lubricated with food grade silicone lubricant.
- 7 Re-install housing cartridge counter clockwise and tighten (do not over tighten).
- 8 Turn main water supply on slowly to allow the system to fill, the air will expel through the open faucet.
- 9 Run water at the nearest cold water faucet for 10 minutes to flush the system.
- 10 Close faucet and check for leaks.

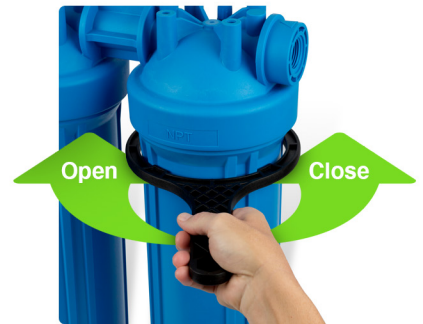

Please note:



Ensure all cartridges are centered and properly seated down into housing.

If you are looking for replacement parts, or need help, please visit kindwater.com or call 888-614-5559 during normal business hours.

Warranty Information

Limited Lifetime Warranty Policy

All Kind whole house water filters / salt-free softeners come with a Limited Lifetime Warranty from manufacturer defects. This warranty covers all E-1000 / E-2000 / E-3000 whole house filter and salt-free softener systems to the original purchaser. Kind Water Systems warrants to the original purchaser and is not transferable. The system must be maintained in normal working conditions and does not cover natural disasters, improper installation, misuse, alterations or modifications, accidents, freezing, or acts of God (such as flood, earthquake, fire, hurricane, lightning, or other natural disasters). Kind Water Systems retains the right to void warranties it finds violates its warranty coverage.

UV System Warranty

Ten (10) Year Limited Warranty on the stainless-steel chambers, Three (3) Year Limited Warranty on the controllers, One (1) Year Warranty on Lamps and Sleeves from the date of original purchase.

Warranty Registrations

All Kind Water Systems are automatically registered for full warranty upon checkout. There is no additional action needed by the consumer.



 **888-614-5559**

480 Fentress Blvd. Suite F, Daytona Beach, FL 32114
Monday - Friday - 9:00 AM - 6:00 PM



UV Quick Reference Guide

KINDH5-151 UV Water Purification System

kindwater.com

Have questions? Call us: 888-614-5559

Assembly

Unpack the system and ensure all the components are included with the system. Your system is shipped with the following components:

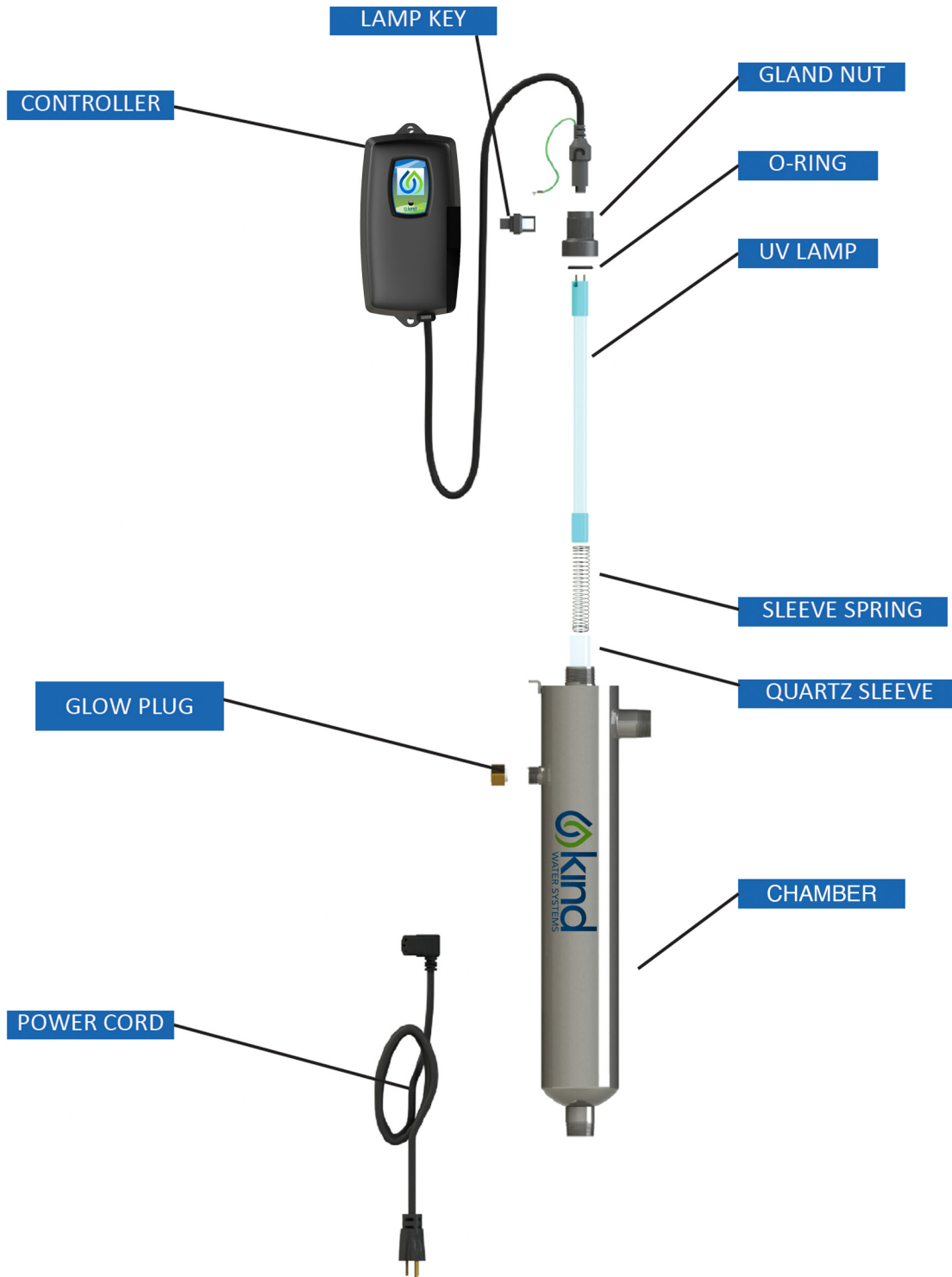

Installation

Caution: Be sure to use metal connections on the inlet/outlet of the UV chamber

Step 1: The chamber can be installed either horizontally or vertically using the clamps provided. Vertical installation is the preferred method with the inlet at the bottom (lamp connection at the top) as it allows any air that may be in the lines to be easily purged from the system.

Step 2: The use of a bypass assembly is recommended as it will allow you to isolate the UV chamber. This will allow for easier access in case maintenance is required.

Step 3: Fasten chamber clamps to wall with screws provided. The screws must anchor securely into solid wood, concrete, or steel structure for adequate strength. Do not attempt to secure screws into drywall (Figure 2a). Install chamber into clamps (Figure 2b).

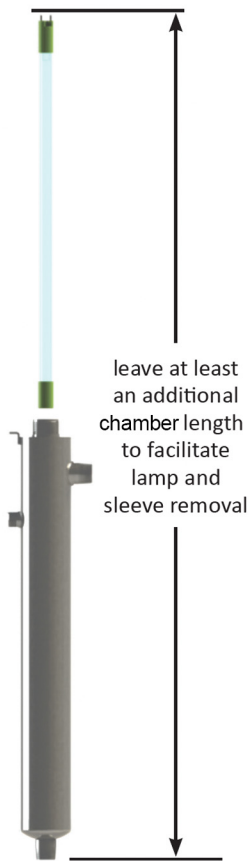

Figure 2a. Securely attach clamps to wall using screws

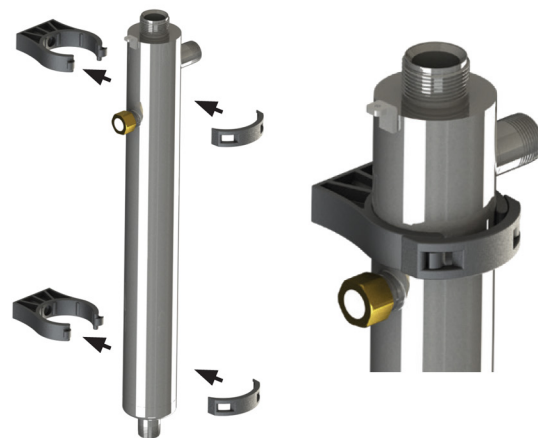
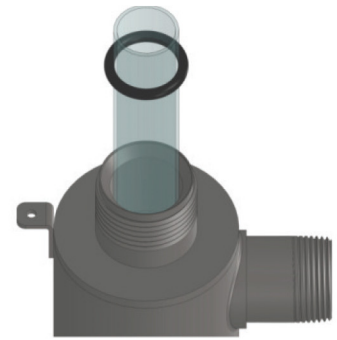

Figure 2b. Install chamber into clamps

Note: Installation of your Kind Water Systems UV Disinfection System shall comply with applicable provincial/state & local regulations.

Installation

Step 4: Once the system has been plumbed in, gently remove the quartz sleeve from its packaging being careful not to touch the length with your hands. The use of cotton gloves is recommended for this procedure as oils from the hands can leave residue on the sleeve and lamp which can ultimately block the UV light from getting to the water. Carefully slide the sleeve into the chamber until you can feel it hit the opposite end of the chamber. Align the sleeve so it centered along the length of the chamber, then gently push it in to lock it into the internal centering springs in the far side of the chamber. CAUTION: Pushing too hard when the sleeve is not aligned can damage the centering springs. Slide the o-ring onto the sleeve until it is butted up against the chamber.



Quartz Sleeve Installation

Step 5: Hand tighten the provided gland nut over the quartz sleeve onto the threaded end of the chamber. It has a positive stop to prevent over-tightening. A firm force may be required to fully tighten the gland nut, but DO NOT USE TOOLS for this step. Insert the provided stainless steel compression spring into the quartz sleeve. The spring works with the lamp and LUMI-Loc™ connector to create the proper lamp alignment. PLEASE NOTE: DO NOT install a UV lamp inside the quartz sleeve without the sleeve spring in place.

Step 6: The chamber is now ready for water flow. When all plumbing connections have been completed, slowly turn on the water supply and check for leaks. Make sure the bypass valves are functioning properly and that the water is flowing through the chamber.

Step 7: Fasten controller securely to wall with screws provided. Drywall anchors may be used. Note that the controller must be mounted vertically for adequate airflow across the aluminum heat sink on back (see Figure 3).



Figure 3. Fasten controller

Installation

Step 8: Always hold UV lamps by their ceramic ends, not by the lamp quartz. Remove the lamp from its packaging. Again, the use of cotton gloves is recommended. Remove the lamp key from the lamp's connector and set it aside for the next step. Be careful to not touch the key's exposed contacts. Insert the UV lamp into the chamber, being careful not to drop it.

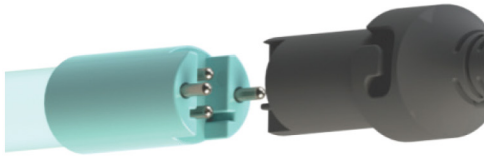

Lamp Connection



Lamp Key

Carefully remove plastic wrapping around UV lamp and remove the lamp key.

Step 9: Install the lamp key into the controller. The key always comes packaged with the lamp and sits on the connector. With the key removed from the lamp, orient it so the label is upright and facing you. The key will plug into the lamp key port on the right side of the controller (Figure 5).

Step 10: Plug the lamp connector into the lamp. Note the keying for proper alignment. Insert the lamp connector into the gland nut and turn the connector approximately ¼ turn to lock the connector to the gland nut as in Figure 6.



Figure 5. Lamp Key Installation



Figure 6. Lamp Connector Installation

Step 11: Tighten the captive ground screw to the ground lug on the UV chamber to ensure proper grounding.

Step 12: Your system is now ready to be plugged into the appropriate GFCI protected outlet. Once plugged in the system will go into its warm up and calibration.

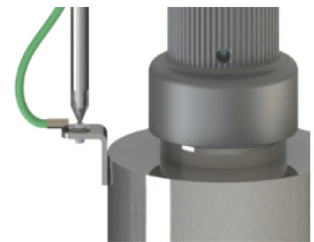

Step 13: Your UV installation is now complete



For the full manufacturer's Installation & Operation manual please use this QR code