



Installation & Operation

KINDH5-151 UV Water Purification System

kindwater.com

Have questions? Call us: 888-614-5559

Kind KINDH5 Series UV Disinfection System

Congratulations on purchasing the Kind Water Systems Ultraviolet Disinfection System. By purchasing a Kind Water Systems UV Disinfection System, you are receiving, not only a high-quality product but also peace of mind. Installing a UV system gives you the reassurance that the water in your home will have an extra level of protection. This process is simple in its concept and effective in its ability to disinfect your water. Simple maintenance and continuous disinfection: **Kind Water Systems makes it that easy.**



Gallons Per Minute: 15 GPM

Table of Contents

Page 4	Safety Considerations
Page 5	Before You Begin
Page 6	Assembly
Page 7	Location
Page 8	Installation
Page 11	Cleaning The Quartz Sleeve
Page 12	Controller
Page 15	System Suggested Service
Page 16	System Troubleshooting
Page 17	Equipment Specifications
Page 18	Warranty Information

Safety Considerations

KINDH5-151 UV Water Purification System

It is important that care is taken when operating and/or maintaining your system.

Please Read The Instructions

- The appliance is not to be used by persons (including children) with reduced physical, sensory or mental capabilities, or lack of experience and knowledge, unless they have been given supervision or instruction.
- Children should be supervised so that they do not to play with the appliance.
- **WARNING:** Do not operate the UV-C emitter when it is removed from the appliance enclosure.
- The appliance is to be supplied through a residual current device (RCD) having a rated residual operating current not exceeding 30 mA.
- This appliance contains a UV-C emitter.
- Unintended use of the appliance or damage to the housing may result in the escape of dangerous UV-C radiation. UV-C radiation may, even in little doses, cause harm to the eyes and skin.
- The appliance must be disconnected from the supply before replacing the UV-C emitter.
- The appliance is intended to be permanently connected to the water mains and not connected by a hose-set.
- Maximum working voltage of built-in UV driver U-OUT=240V
- If the supply cord is damaged, it must be replaced by the manufacturer, its service agent or similarly qualified persons in order to avoid a hazard.
- Before servicing this equipment, disconnect the power cord from the electrical outlet.
- **Energy given off by the UV lamp is harmful to your eyes and skin.** NEVER look directly at an illuminated UV lamp without adequate eye protection and always protect your skin from direct exposure to the UV light.
- For complete disinfection, use ONLY genuine replacement parts.
- Do not operate the unit if it has any damaged or missing components. • To avoid possible electrical shock, use only with a properly grounded electrical outlet.
- Never perform any maintenance to the system unless you are comfortable in doing so. Contact the manufacturer for service instructions if required.
- Do not use this system for any purpose other than what it was intended for. Misuse of this system could potentially cause harm to the user or others.
- Your system is intended to be installed indoors and away from leaking plumbing. DO NOT plug the unit in if the system or any of the components are wet.
- The disinfection system should be directly installed into a ground fault circuit interrupter (GFCI). If the use of an extension cord is required, the cord must be manufactured with a minimum of 16 gauge wire and care should be taken to avoid potential tripping hazards.
- We recommend that a licensed plumber or certified technician install the system.

This product is not to be used for general lighting / illumination.

Before You Begin

The following will be needed for installing the UV system:

Water Quality Parameters

UV disinfection is only effective if the UV light can pass through the water it needs to treat. This means that the quality of your water is very important in order to ensure complete disinfection. Treated water should be tested for at the least the parameters listed below. If the water exceeds the listed parameters Kind Water Systems strongly recommends that appropriate pretreatment equipment be installed (equipment required will depend on parameters being treated):

Hardness: <7 gpg (120 mg/L) – if hardness level is 7 gpg or slightly below the quartz sleeve must be cleaned periodically in order to ensure efficient

UV penetration: if above the water must be softened.

Iron (Fe): <0.3 ppm (0.3 mg/L)

Manganese (Mn): <0.05 ppm (0.05 mg/L)

Turbidity: < 1 NTU

Tannins (organics): <0.1 ppm (0.1 mg/L)

UVT (transmittance): >85% (Please contact Kind Water Systems if water has a UVT that is less than 80% for pre-treatment recommendations)

You can have your water tested at a private analytical laboratory or by your local dealer. It is always recommended to install pre-filtration of at least 5 microns prior to an Kind Water Systems UV Disinfection System.

Assembly

Unpack the system and ensure all the components are included with the system. Your system is shipped with the following components:

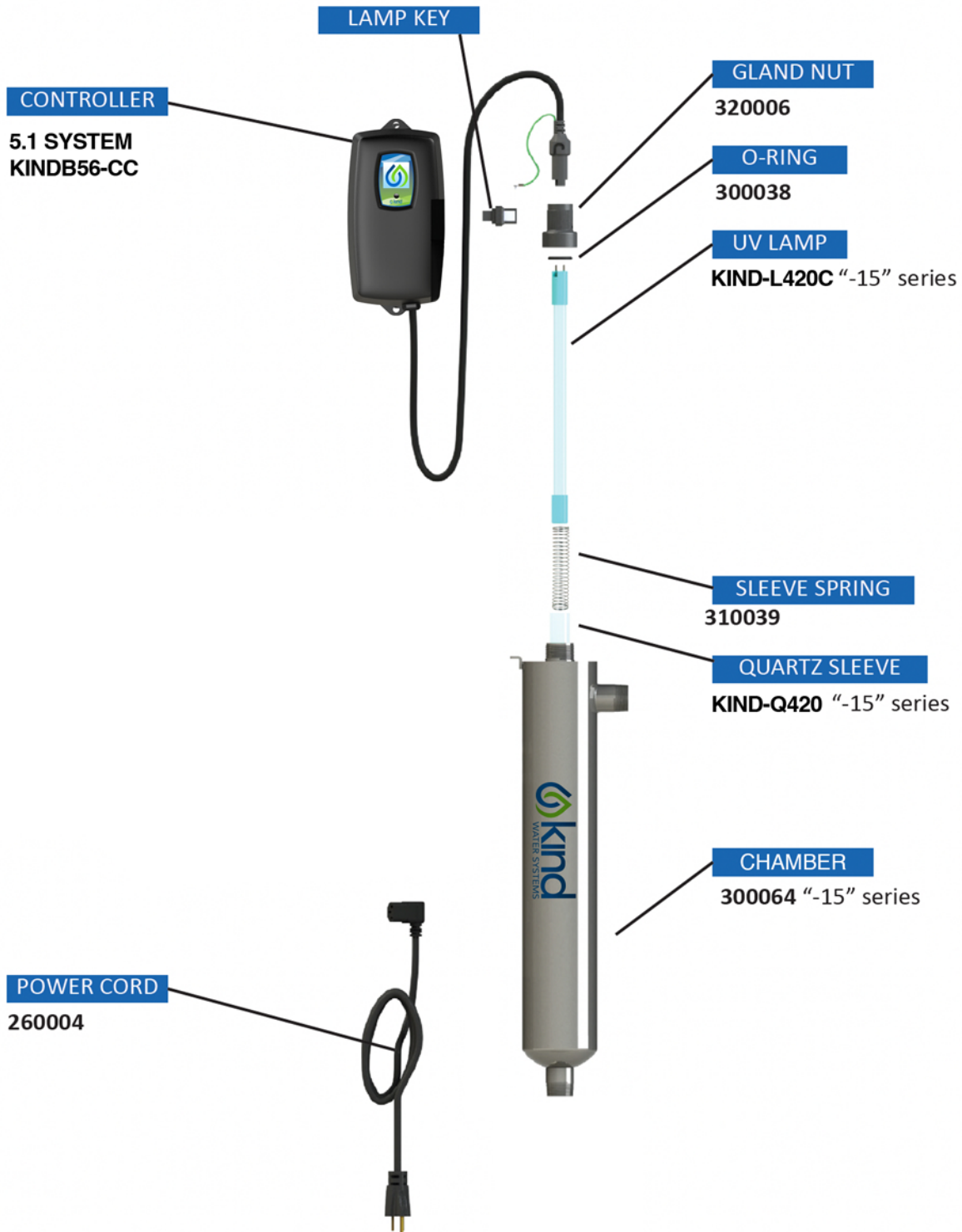

Location

For Point of Entry (POE) systems, choose a location where the main cold water line is accessible. The system must be installed after other water treatment equipment (softener or filters), but before any branches (See Figure 1). For Point of Use (POU) systems, install the unit just **before** the faucet. Kind Water Systems recommends that a 5 micron filter be installed before the UV system for a final polishing step before the water is disinfected. See diagram below for reference.

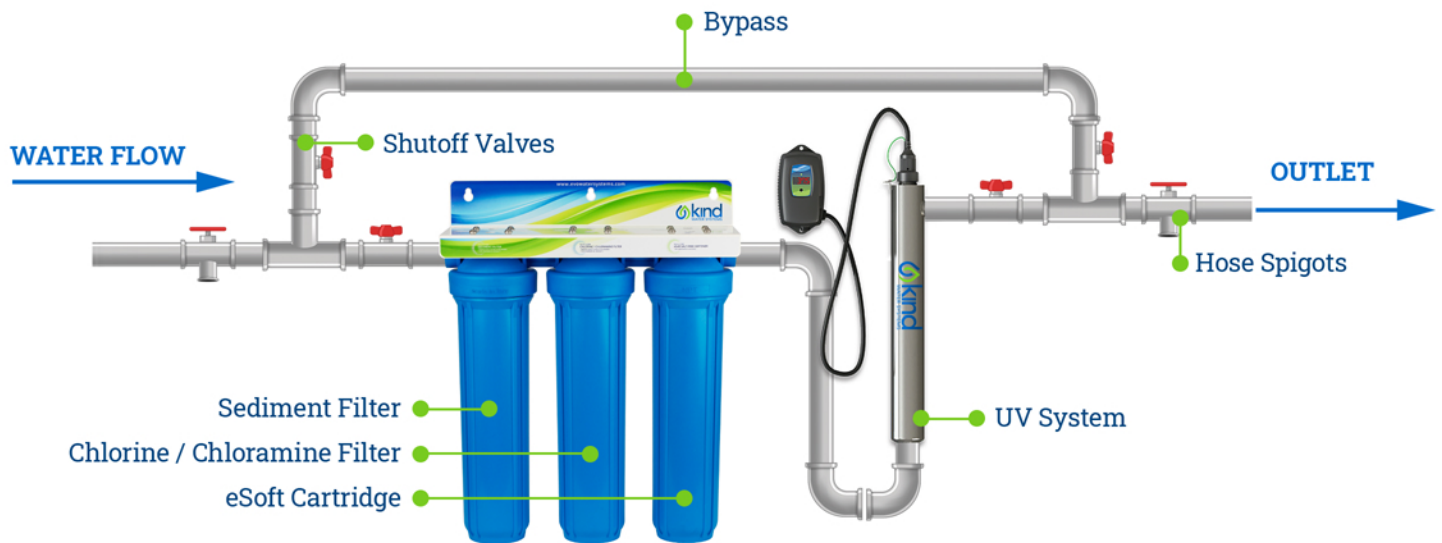

Figure 1. Recommended POE Installation Location

To facilitate lamp removal, ensure there is enough space at the lamp connector end to safely remove the UV lamp and/or quartz sleeve. The controller will require a ground fault circuit interrupter (GFCI or GFI) outlet and should be mounted beside or above the chamber.

PLEASE NOTE: All Kind Water Systems UV Disinfection Systems are intended for indoor use only as they should not be exposed to the elements.

Installation



Step 1: The chamber can be installed either horizontally or vertically using the clamps provided. Vertical installation is the preferred method with the inlet at the bottom (lamp connection at the top) as it allows any air that may be in the lines to be easily purged from the system.

Step 2: The use of a by-pass assembly is recommended as it will allow you to isolate the UV chamber. This will allow for easier access in case maintenance is required.

Step 3: Fasten chamber clamps to wall with screws provided. The screws must anchor securely into solid wood, concrete, or steel structure for adequate strength. Do not attempt to secure screws into drywall (Figure 2a). Install reactor into clamps (Figure 2b).



Figure 2a. Install chamber into clamps

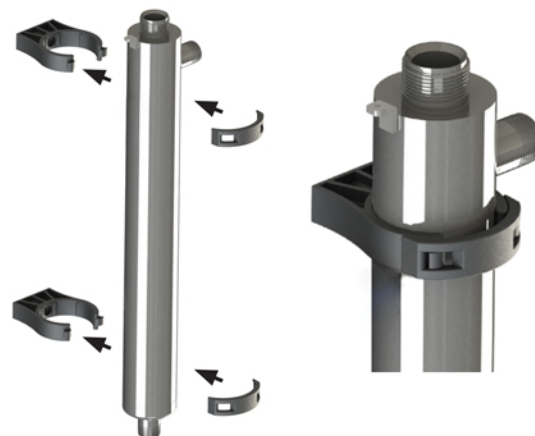
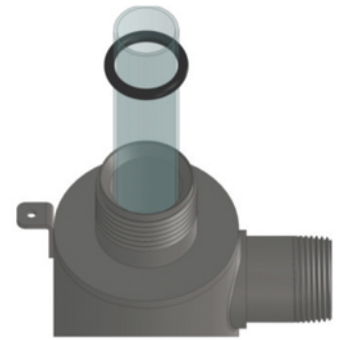

Figure 2b. Install chamber into clamps

Note: Installation of your Kind Water Systems UV Disinfection System shall comply with applicable provincial/state & local regulations.

Installation

Step 4: Once the system has been plumbed in, gently remove the quartz sleeve from its packaging being careful not to touch the length with your hands. The use of cotton gloves is recommended for this procedure as oils from the hands can leave residue on the sleeve and lamp which can ultimately block the UV light from getting to the water. Carefully slide the sleeve into the chamber until you can feel it hit the opposite end of the chamber. Align the sleeve so it centered along the length of the chamber, then gently push it in to lock it into the internal centering springs in the far side of the chamber. CAUTION: Pushing too hard when the sleeve is not aligned can damage the centering springs. Slide the o-ring onto the sleeve until it is butted up against the chamber.



Quartz Sleeve Installation

Step 5: Hand tighten the provided gland nut over the quartz sleeve onto the threaded end of the chamber. It has a positive stop to prevent over-tightening. A firm force may be required to fully tighten the gland nut, but DO NOT USE TOOLS for this step. Insert the provided stainless steel compression spring into the quartz sleeve. The spring works with the lamp and LUMI-Loc™ connector to create the proper lamp alignment. PLEASE NOTE: DO NOT install a UV lamp inside the quartz sleeve without the sleeve spring in place.

Step 6: The chamber is now ready for water flow. When all plumbing connections have been completed, slowly turn on the water supply and check for leaks. Make sure the by-pass valves are functioning properly and that the water is flowing through the chamber.

Step 7: Fasten controller securely to wall with screws provided. Drywall anchors may be used. Note that the controller must be mounted vertically for adequate airflow across the aluminum heat sink on back (see Figure 3).



Figure 3. Fasten controller

Installation

Step 8: Always hold UV lamps by their ceramic ends, not by the lamp quartz. Remove the lamp from its packaging. Again, the use of cotton gloves is recommended. Remove the lamp key from the lamp's connector and set it aside for the next step. Be careful to not touch the key's exposed contacts. Insert the UV lamp into the chamber, being careful not to drop it.

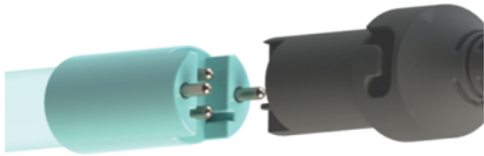

Lamp Connection



Lamp Key

Carefully remove plastic wrapping around UV lamp and remove the lamp key.

Step 9: Install the lamp key into the controller. The key always comes packaged with the lamp and sits on the connector. With the key removed from the lamp, orient it so the label is upright and facing you. The key will plug into the lamp key port on the right side of the controller (Figure 5).

Step 10: Plug the lamp connector into the lamp. Note the keying for proper alignment. Insert the lamp connector into the gland nut and turn the connector approximately ¼ turn to lock the connector to the gland nut as in Figure 6.



Figure 5. Lamp Key Installation



Figure 6. Lamp Connector Installation

Step 11: Tighten the captive ground screw to the ground lug on the UV chamber to ensure proper grounding.

Step 12: Your system is now ready to be plugged into the appropriate GFCI protected outlet. Once plugged in the system will go into its warm up and calibration.

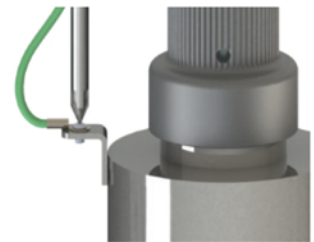

Step 13: Your UV installation is now complete



For the full manufacturers Installation & Operation manual please use this QR code

Cleaning The Quartz Sleeve

Depending on the water quality, the quartz sleeve may require periodic cleaning. At a minimum, the quartz sleeve should be cleaned on an annual basis. The following steps outline a basic cleaning procedure.

Step 1: If a by-pass assembly is installed, shut the inlet valve off to prevent water flow through the system. Otherwise, turn off main water inlet valve (and/or turn off the water pump).

Step 2: Disconnect power cord of UV system from electrical outlet.

Step 3: Release water pressure by opening a downstream faucet and then close the outlet shut-off valve (if any). If there is no outlet shut-off valve, expect water to drain from the system as the head pressure in the system will cause the water to flow back down.

Step 4: Remove the captive ground screw from the ground lug on the UV chamber.

Step 5: Remove the lamp connector from the chamber (gland nut) by pushing the LUMI-loc connector in and turning it ¼ turn counter-clockwise. Disconnect the lamp connector from the lamp. CAUTION: the lamp may be hot!

Step 6: Being careful to touch only the ceramic ends, remove the lamp out of the chamber.

Step 7: Unscrew the gland nut from the chamber exposing the end of the quartz sleeve.

Step 8: Remove the quartz sleeve and o-ring by gently twisting and pulling the quartz sleeve.

Step 9: Using a soft, lint-free cloth or towel wipe the sleeve down using a commercial scale cleaner (i.e. CLR® or LIME-A-WAY®). This removes scaling or iron deposits that may be on the outside of the quartz sleeve. Be careful not to get any moisture or liquids inside of the sleeve.

Step 10: Dry the sleeve with separate cloth.

Step 11: Replace the o-ring and slide the sleeve back into the chamber following steps 5 and 6 from the installation section of the manual.

Controller



A full color LCD screen provides the user with a detailed description of the system's performance in addition to providing any applicable fault messages and system diagnostics.

KINDH5 Power-up Sequence

On start up, the controller will run through a diagnostic start-up and the sequence will be displayed as follows on the color LCD:



Controller

The controller then displays the lamp optimization screen for 60 seconds to allow the lamp to reach its optimum output. Finally, a final “start-up complete” screen is displayed. The system will now be ready to disinfect water flow.



lamp reaching max output



successful start-up

KINDH5 Operational Screens

At any point during operation the user is able to scroll through the Home Screen, Lamp life remaining, QR Code, Contact Info and Maintenance Parts screens by pressing the button located on the front of the controller.



Controller

Lamp Countdown Sequence

The system counts down the number of days until a lamp change is required.



At thirty days remaining, the LED or display screen will change to a yellow caution indicator. At seven days remaining, the system will additionally repeat an audible chirp. Past the zero day threshold, the LED or display screen changes to solid red with a continuous buzzer.



At any point during this sequence, the audible chirp or alarm can be deferred for seven days by holding the controller button down for a period of five seconds. The number of deferrals used will be displayed as below. Once the deferral expires, the alarm will sound once again. The deferral can be repeated up to three times. PLEASE NOTE: At any point after lamp expiration, the water may be unsafe for consumption and should not be consumed without another form of disinfection.



System Suggested Service

Lamp Replacement (KINDH5 system)

After the lamp is expired, it must be replaced with the same part number as indicated on the Maintenance Parts screen or on the label on the chamber. With the system powered down, remove and discard the lamp key from the controller. The replacement lamp is packaged with a lamp key on the connector at the end of the lamp. Remove the key from the lamp and place it in the controller. Refer to Installation, starting with step 10 (page 10) for instructions on installing the new lamp.

QR Codes





Kind Water Systems uses the QR code to store a link to a specific page on our website. Users with a camera phone equipped with the correct reader application can scan the image of the QR code and over a wireless network connect to a Kind Water Systems web page in the phone's browser. Kind Water Systems QR webpage has information on how to purchase replacement components as well as a helpful video directory on system servicing (i.e. How to change a UV lamp or quartz sleeve). To access the QR code on the controller, press the control button until the QR code screen appears.



Visit KindWater.com

System Troubleshooting

Hard Alarms: The following give a constant audible alarm. If present, the solenoid valve is closed, and the 4-20, remote alarm and wifi modules transmit the alarm.

System Display	Problem	Resolution
 <p>DANGER lamp failure replace lamp</p>	The system has detected a problem with the lamp.	Reset lamp protection circuit -unplug unit for 10 seconds. Replace the lamp with the part as indicated on the silver label on the chamber or on the Maintenance parts screen.
 <p>DANGER lamp expired 1 days ago press button for lamp change info.</p>	Although the lamp is powered and visibly illuminated, due to the lamp's age its UV output is no longer sufficient for proper disinfection.	Replace the lamp with the part as indicated on the silver label on the chamber or on the Maintenance parts screen.
 <p>LAMP INCORRECT Required Part: KIND-L420C Installed Part: KIND-L290</p>	Wrong lamp installed.	Replace component with proper model as indicated.
 <p>LAMP KEY NOT FOUND check connection or see manual</p> <p>LAMP KEY INVALID check connection or see manual</p>	Missing or incorrect lamp key.	Ensure the lamp key (packed with the lamp, on the connector) is installed. Unplug and reinstall the key. Ensure the key part number matches Lamp on Maintenance Parts screen.

Boil Water Advisory: If any failure occurs on a Kind Water Systems UV system, the water must not be used for human consumption until the system is returned to a safe operational mode. If the water is used for human consumption during this period, the water must be boiled (minimum 20 minutes at a full boil) prior to consumption.

Equipment Specifications

	EQUIPMENT SPECIFICATIONS	
	Residential systems	
MODEL	KINDH5-151	
Flow Rate 30mJ/cm ² @ 95% UVT	15 gpm	
	57 lpm	
	3.4 m ³ /hr	
Flow Rate 40mJ/cm ² @ 95% UVT	11 gpm	
	42 lpm	
	2.5 m ³ /hr	
Flow Rate Hot Water (-HW suffix) model 30mJ/cm ² @ 75% UVT	9.8 gpm	
	37 lpm	
	2.2 m ³ /hr	
Flow Rate Low UVT (-50 suffix) model 30mJ/cm ² @ 50% UVT	6.1 gpm	
	23 lpm	
	1.4 m ³ /hr	
Flow Rate TOC (-TOC suffix) model 150mJ/cm ² @ 98% UVT	2.8 gpm	
	11 lpm	
	0.6 m ³ /hr	
Port Size	1" MNPT	
Electrical	90-265V/50-60Hz. 1.5A Max.	
Plug Type	American: NEMA 5-15P	
Lamp Power (Watts)	45	
Power (Watts)	48	
Replacement Lamp	KIND-L420C	
Replacement Sleeve	KIND-Q420	
Reactor Dimensions	8.9 x 50.8 cm (3.5 x 20.0")	
Chamber Material	316L Stainless Steel, A249 Pressure Rated Tubing	
Controller Dimensions	217.4 x 107.5 x 101.6 mm (8.6 x 4.2 x 4")	
Operating Pressure	0.7-10.3 bar (10-150 psi)	
Operating Water Temperature	2-40° C (36-104° F)	
Lamp Change Reminder	YES	
Lamp Out Indicator	YES	
Shipping Weight	5.6 kg (12.9 lbs)	

Limited Warranty Information

Limited Warranty Statement:

Products manufactured by Kind Water Systems are warranted to the original user only to be free of defects in material and workmanship for a period as specified below. This warranty only applies to the original purchaser and is not transferable.

UV SYSTEMS

Ten (10) year Limited Warranty on the stainless steel chamber, from the date of original purchase.

ELECTRONICS

Three (3) year Limited Warranty on the controllers, from the date of original purchase.

UV LAMPS & QUARTZ SLEEVES

One (1) year Limited Warranty on all ultraviolet lamps and quartz sleeves from the date of original purchase

This Kind Water Systems Ultraviolet Disinfection System will be repaired or replaced, at our sole option, providing that the ultraviolet system or any component is defective in materials or workmanship for the periods outlined above and subject to the "Limitations of Warranty" as outlined below. Kind Water Systems liability under this warranty shall be limited to repairing or replacing the product, without charge, F.O.B. Kind Water Systems' closest Distribution Facility or authorized service depot. Kind Water Systems will not be liable for any costs of removal, installation, transportation, or any other charges which may arise in connection with a warranty claim. Kind Water Systems will not be liable for damage or wear to products caused by abnormal operating conditions, accident, abuse, misuse, unauthorized alteration or repair, or if the product was not installed in accordance with the Manufacturers printed installation and operating instructions.

LIMITATIONS OF WARRANTY

This warranty does not apply to any of the following:

- Water Quality Parameters lie outside of the following ranges
 - Hardness > 120 mg/L (7 gpg)
 - Iron > 0.3 mg/L (ppm)
 - Manganese > 0.05 mg/L (ppm)
 - Tannins > 0.1 mg/L (ppm)
 - Turbidity > 1 NTU
 - Transmittance (UVT) < 75%
- A product that has been incorrectly installed according to the technical installation manual.
- A product that has been modified in any manner, unless approved by the manufacturer.
- A product where the serial number has been altered, defaced or removed.
- Damage caused by the use of parts that are not compatible, suitable and/or authorized by Kind Water Systems for use with the product (e.g. non-original lamps or sleeves).
- Damage caused during shipment of the product.
- Water damage is found inside controllers.
- Product is installed outdoors in direct contact with the environment (rain).
- Product is installed in freezing temperatures.
- Product is used in conditions that exceed Kind Water Systems specifications.

Limited Warranty Information

TO GET WARRANTY SERVICE

Please contact the Dealer or Distributor where the product was originally purchased to obtain service under this warranty. Your Dealer / Distributor will obtain a Warranty Return Authorization and will then need to return the product to Kind Water Systems, together with proof of purchase and installation date, failure date, and supporting installation data. Any defective product to be returned must be sent freight prepaid.

KIND WATER SYSTEMS WILL NOT BE LIABLE FOR ANY INCIDENTAL OR CONSEQUENTIAL DAMAGES, LOSSES, OR EXPENSES ARISING FROM INSTALLATION, USE, OR ANY OTHER CAUSES. THERE ARE NO EXPRESS OR IMPLIED WARRANTIES, INCLUDING MERCHANTABILITY OR FITNESS FOR A PARTICULAR PURPOSE, WHICH EXTEND BEYOND THOSE WARRANTIES DESCRIBED OR REFERRED TO ABOVE.

THIS LIMITED WARRANTY IS THE SOLE AND EXCLUSIVE WARRANTY MADE BY KIND WATER SYSTEMS WITH RESPECT TO THIS ULTRAVIOLET DISINFECTION PRODUCT, AND IS GIVEN IN LIEU OF ANY OTHER WARRANTY. TO THE EXTENT ALLOWED BY APPLICABLE LAW, ANY AND ALL EXPRESS OR IMPLIED WARRANTIES NOT SET FORTH HEREIN ARE WAIVED AND DISCLAIMED, INCLUDING ANY IMPLIED WARRANTY OF MERCHANTABILITY OR FITNESS FOR A PARTICULAR USE. KIND WATER SYSTEMS LIABILITY UNDER THIS LIMITED WARRANTY IS LIMITED SOLELY TO THOSE LIABILITIES SET FORTH ABOVE. IN THE EVENT THAT ANY PROVISION OF THIS LIMITED WARRANTY SHOULD BE FOUND TO BE OR BECOME INVALID OR UNENFORCEABLE UNDER APPLICABLE LAW, THE REMAINING TERMS AND CONDITIONS HEREOF SHALL REMAIN IN FULL FORCE AND EFFECT AND SUCH INVALID OR UNENFORCEABLE PROVISION SHALL BE CONSTRUED IN SUCH A MANNER AS TO BE VALID AND ENFORCEABLE.